

VIEW	TOLERANCE	
	0-5	±0.1
	6-10	±0.25
	11-50	±0.5
UNIT: mm	51-100	±1
	101-250	±2
	251-500	±5
	501- >	±10

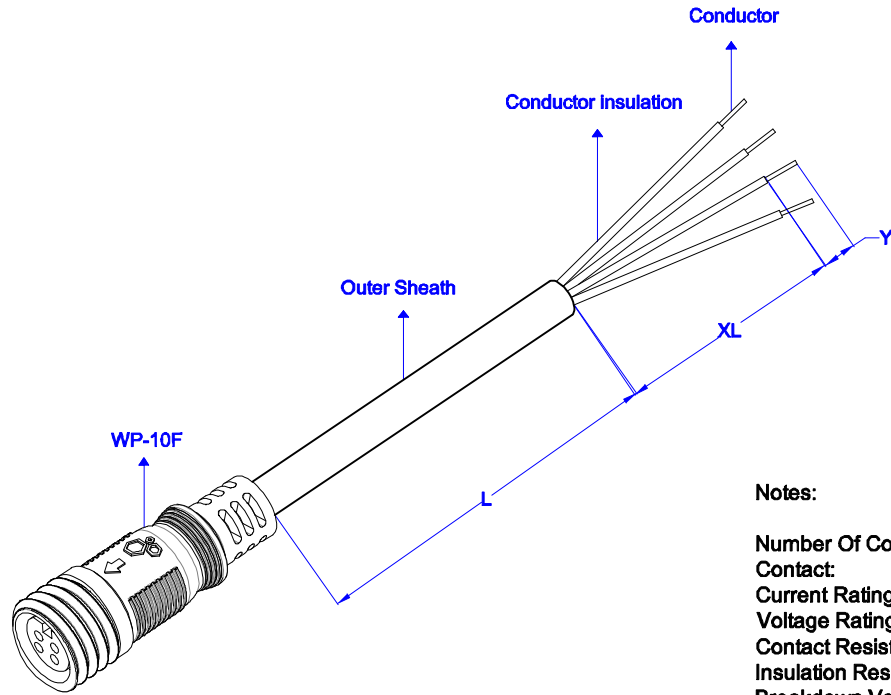

Notes:

Number Of Contact: 4 Pin
 Contact: Brass Nickel Plated
 Current Rating Percontact: 2,5A
 Voltage Rating: 220V AC
 Contact Resistance: <10M Ω
 Insulation Resistance: 1000M Ω at DC 500V.
 Breakdown Voltage: 1,5KV / 1 minute
 Temperature Rating: -30C°~+70C°
 Durability (Plug/Unplug): 3000 times
 Waterproof Rating: IP67
 Certificate: CE ; ROHS

ORDER CODE:

WP-10F XXXX XX X XXX XX X
 ↳ Cable : CI: PVC H05VV-F (TTR) 4x0,50mm² O.D: 5,8 ±0.2
 ↳ Color : B: Black W : White
 ↳ Outer Sheath Striping : if yes: XL (mm) if not: 00
 ↳ Conductor insulation Striping : if yes: YL (mm) if not: 00
 ↳ Conductor Solder : if yes: Y if not: 0
 ↳ Length : L (mm)

No	Material Code	Description	Size (mm)	Q'ty	Unit
6	-	PVC MOLDING (black or white)	-	-	-
5	-	PVC NUT (black or white)	-	-	pc.
4	-	GASKET (red)	-	-	pc.
3	-	TERMINAL - FEMALE	-	-	pcs.
2	-	TERMINAL - MALE	-	-	pcs.
1	-	IEC 62(RVV) 300/300V 4x0.50mm ² CABLE (black or white)	-	-	pcs.

Date	16.12.2016	Rev.	-	Revision Detail		Rev.Dt.		Rev.by		Part No	WP-10F 4 Pin Seal Harness		
Designed by	Yegim AKSOY	Checked by	Fatih BOLACA							Drawing Nr.	Scale	Sheet No	
										-	NONE	1/2	



A
B
C
D
A4

" Dimensions (mm) "

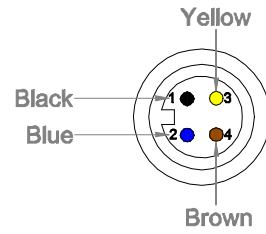

front view

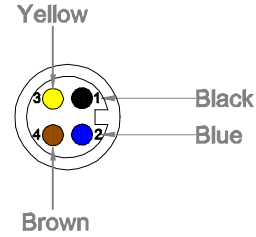

WP-10M

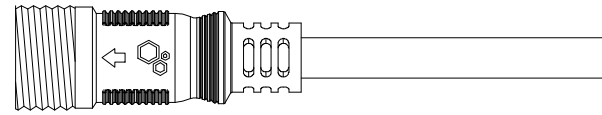
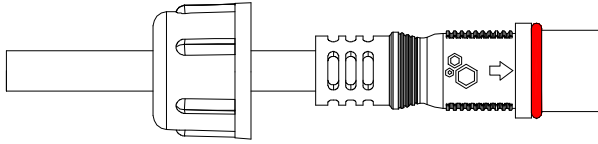

WP-10F

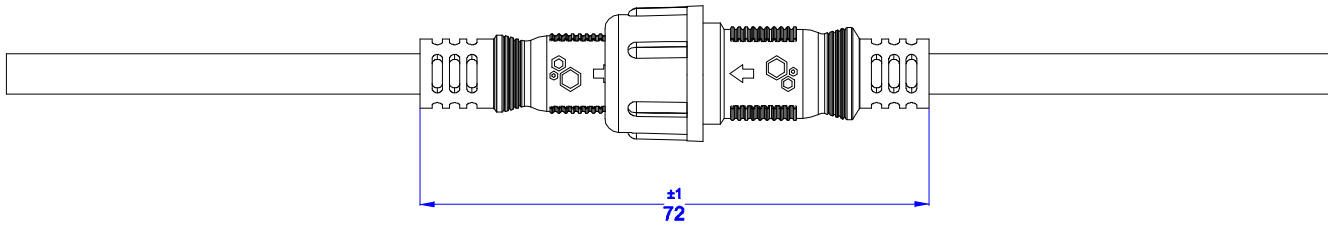
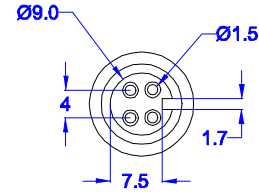
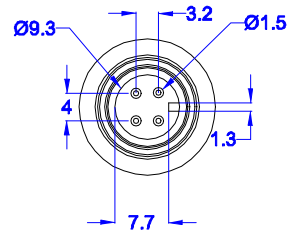

Date	16.12.2016	Rev.		Revision Detail	Rev.Dt.	Rev.by	Part No		
Designed by	Yegim AKSOY	-					WP-10F / WP-10M Connection Details		
Checked by	Fatih BOLACA						Drawing Nr.	Scale	Sheet No
							-	NONE	2/2



1

2

3

4

5

6

A4