

VIEW	TOLERANCE	
	0-5	±0.1
	6-10	±0.25
	11-50	±0.5
UNIT: mm	51-100	±1
	101-250	±2
	251-500	±5
	501- >	±10

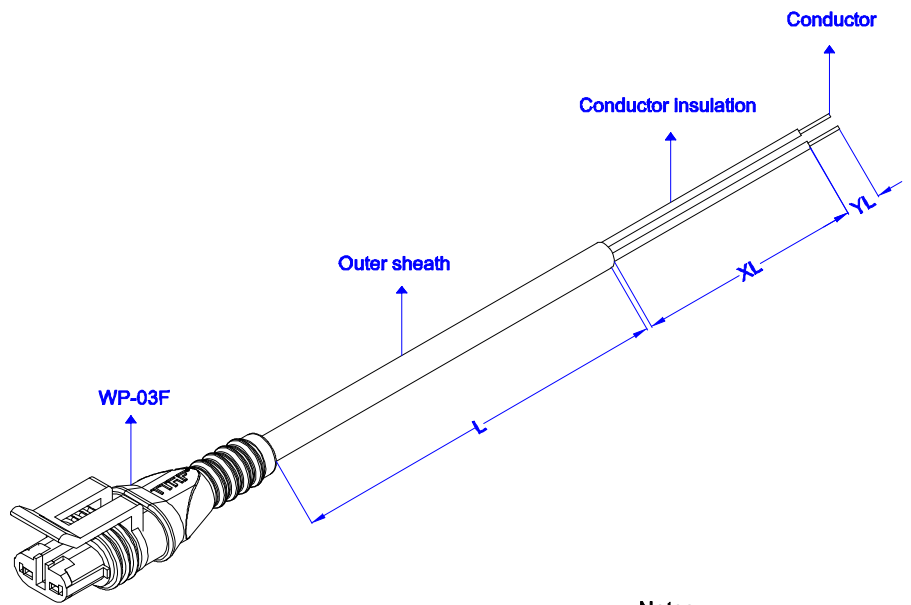

ORDER CODE:

WP-03F XXXX XX X XXX XX X

Conductor Solder :
 if yes: Y
 if not: 0

Conductor insulation Stripping :
 if yes: YL (mm)
 if not: 00

Outer sheath Stripping :
 if yes: XL (mm)
 if not: 00

Color : B: Black W: White

Cable :	CA : PVC H05VXF (TTR)	2x0,5mm ²	OD: 4,6mm ±0.2
	CB : PVC H05VXF (TTR)	2x0,75mm ²	OD: 6mm ±0.2
	CC : PVC H05VXF (TTR)	2x1,00mm ²	OD: 6,2mm ±0.2
	CD : PVC H05VXF (TTR)	2x1,50mm ²	OD: 6,8mm ±0.2
	PA: PUR H05VVF(TTR)	2x0,5mm ²	OD: 4,6mm ±0.2
	PB: PUR H05VVF(TTR)	2x0,75mm ²	OD: 6mm ±0.2
	PC: PUR H05VVF(TTR)	2x1,00mm ²	OD: 6,2mm ±0.2
	PD: PUR H05VVF(TTR)	2x1,50mm ²	OD: 6,8mm ±0.2

Length: L (mm)

Notes:



- Connector Specification; Material: PA66+GF
 Number Of Contacts: 2 pin
 Temperature Range: -30C°~+70C°
 Terminal Material: Phosphor Bronze
 Terminal Plate: Pre-Tin
 Current Rating Per Contact;
 0,5 mm² Cable Max. 6A
 0,75 mm² Cable Max. 7A
 1,00 mm² Cable Max. 8A
 1,50 mm² Cable Max. 11A

2) Molding Material: PVC or PUR depends for cable order

3) Housing Part No: 200001-2F
 Terminal Part No: 200001-TF-C

Date	30.11.2016	Rev.	-	Revision Detail		Rev.Dt.		Rev.by		Part No	WP-03F 2 Pin Seal Harness		
Designed by	Yegim AKSOY	Checked by	Fatih BOLACA							Drawing Nr.	Scale	Sheet No	
										-	1:2	1/3	



VIEW	TOLERANCE	
	0-5	±0.1
	6-10	±0.25
	11-50	±0.5
	51-100	±1
	101-250	±2
	251-500	±5
	501- >	±10

UNIT: mm

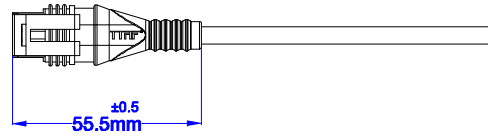
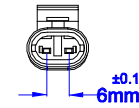
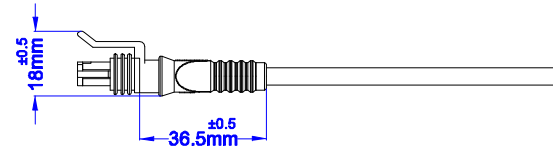
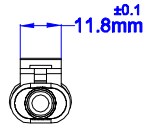
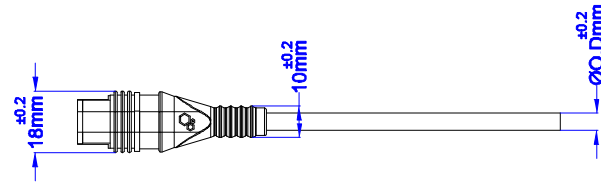
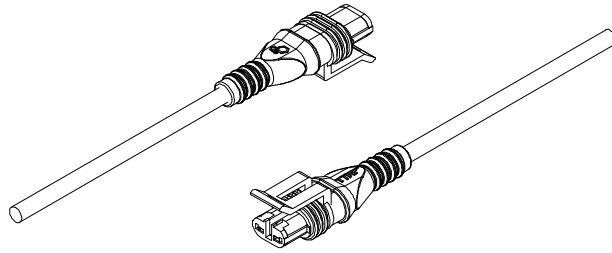

Date	30.11.2018	Rev.	-	Revision Detail		Rev.Dt.		Rev.by		Part No	WP-03F Dimensions		
Designed by	Yasim AKSOY												
Checked by	Fatih BOLACA												
										Drawing Nr.	Scale	Sheet No	
										-	1:2	2/3	

VIEW	TOLERANCE	
	0-5	±0.1
	6-10	±0.25
	11-50	±0.5
UNIT: mm	51-100	±1
	101-250	±2
	251-500	±5
	501- >	±10

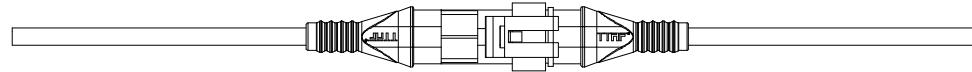
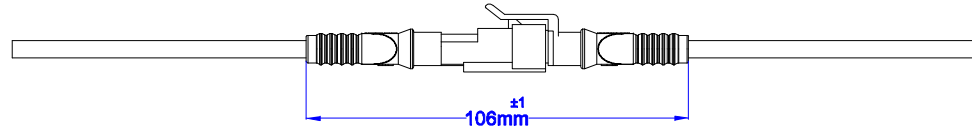
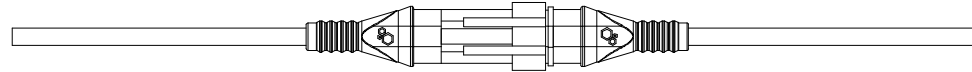
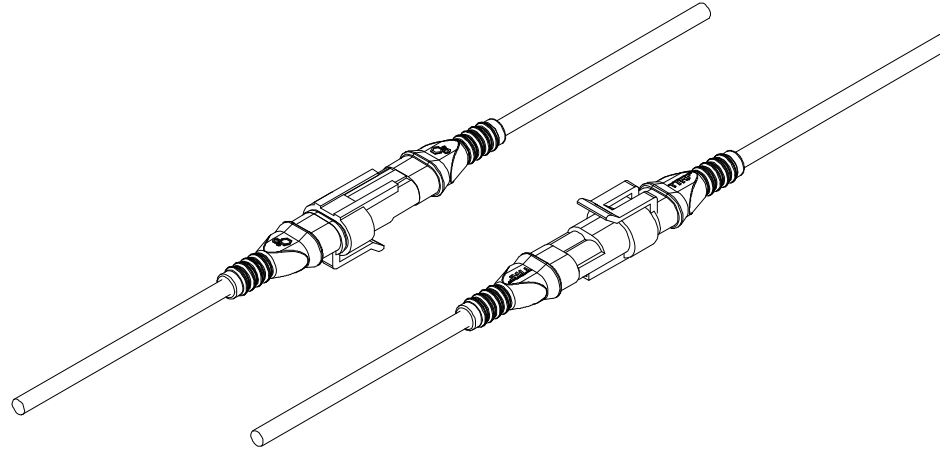

Date	30.11.2016	Rev.		Revision Detail	Rev.Dt.	Rev.by	Part No		
Designed by	Yegim AKSOY	-					WP-03F / WP-06M Connection Details		
Checked by	Fatih BOLACA								
							Drawing Nr.	Scale	Sheet No
							-	1:2	3/3