

1

2

3

4

5

6

A

A

B

B

C

C

D

D

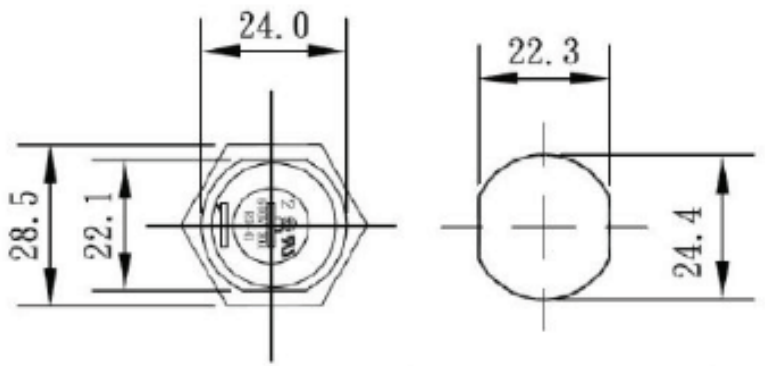
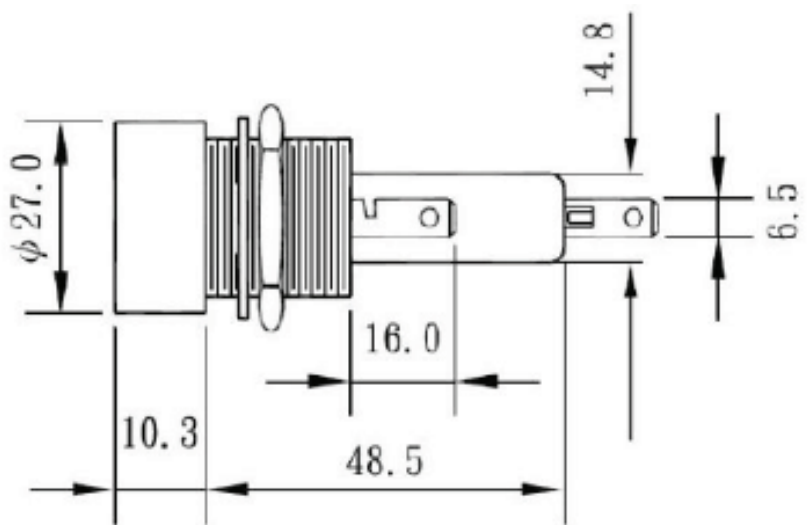

Date	-	Rev.	Revision Detail	Rev.Dt.	Rev.by	Part No		
Designed by	-	-				FS - 08		
Checked by	-							
						Drawing Nr.	Scale	Sheet No
						-	NONE	1/1

1

2

3

4

5

6

A4

Form No: FR-01/004 IYT: -10/2003 Rev:06 09/01/2012