

1

2

3

4

5

6

A

A

B

B

C

C

D

D

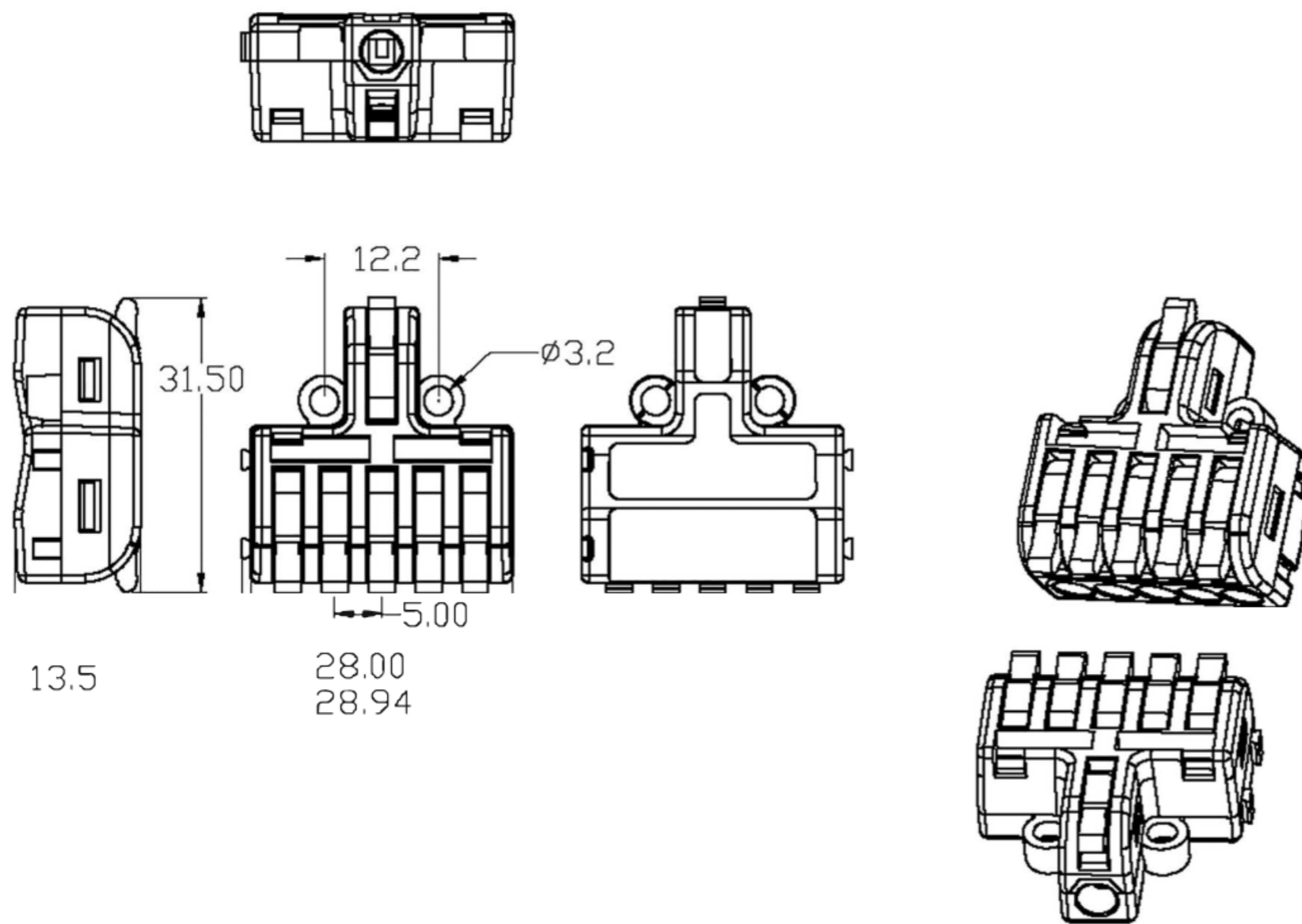

■ SPECIFICATIGNS

■ (Applicable wires) :

Solid wire 0.5-4mm²
Fine wire 0.5-2.5mm²

- (Temperature range) : -40°C+105°C
- (Voltage rating) : 250V
- (Current rating) : 32A
- (Contact resistance) ≤0. 015 Ω
- (Insulation resistance) : ≥1000MΩ
- (Material) :
- (Plastic parts) : PA6 V2
- (LEVER):POM
- (Conductor material) : (copper)
- (Clip) : 301(Stainless steel 301)

Date	-	Rev.	Revision Detail	Rev.Dt.	Rev.by	Part No		
Designed by	Rabia MUZAÇ	-				1 In 5 Out Screwless Terminal Block		
Checked by	Ersin YÜKSEL							
						Drawing Nr.	Scale	Sheet No
						KLM-61	NONE	1/1

1

2

3

4

5

6

A4