

VIEW	TOLERANCE	
	0-10	±1
	11-250	±5
	251-500	±10
	501-1000	±20
	1001-3000	±50
UNIT: mm	3001-5000	±100
	5001- >	±150

▲ Order Code : 200003-02FA

**TTAF
APPROVAL**

NOTE:
1.ALL THE DIMENSIONS ARE MEASURED UNDER
GRADE "B" UNLESS OTHERWISE SPECIFIED.

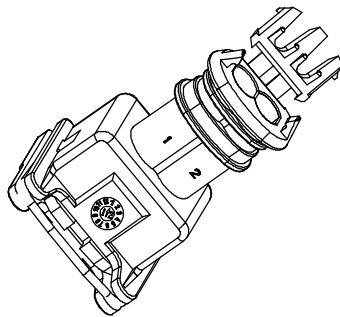
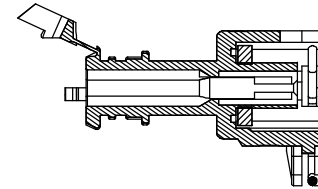
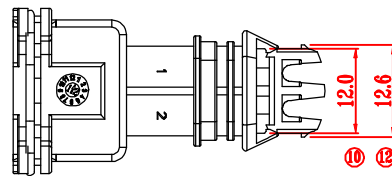
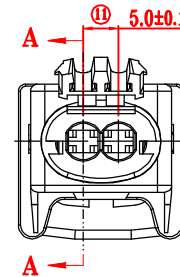
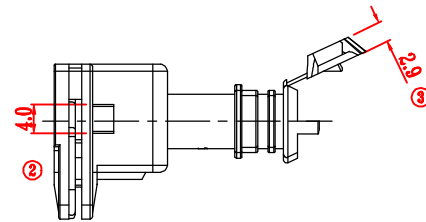
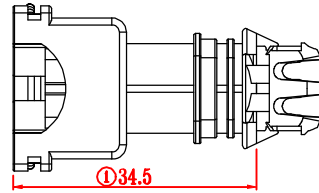
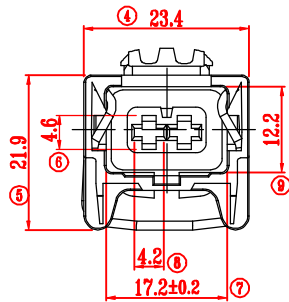

Date	04.01.2016	Rev.		Revision Detail		Rev.Dt.		Rev.by		Part No	200003-02FA		
Designed by	Yeşim AKSOY		-								Drawing Nr.	Scale	Sheet No
Checked by	Fatih BOLACA										-	NONE	1/1