

VIEW	TOLERANCE	
	0-10	±1
	11-250	±5
	251-500	±10
	501-1000	±20
	1001-3000	±50
UNIT: mm	3001-5000	±100
	5001- >	±150

△ Order Code : 200001-6F

**TTAF
APPROVAL**

Materiel PA66 GF
Temperature Range -40°C # +120°C

Current Rating
0,50mm² Kablo Max.6A
0,75mm² Kablo Max.7A
1,00mm² Kablo Max.8A
1,50mm² Kablo Max.11A

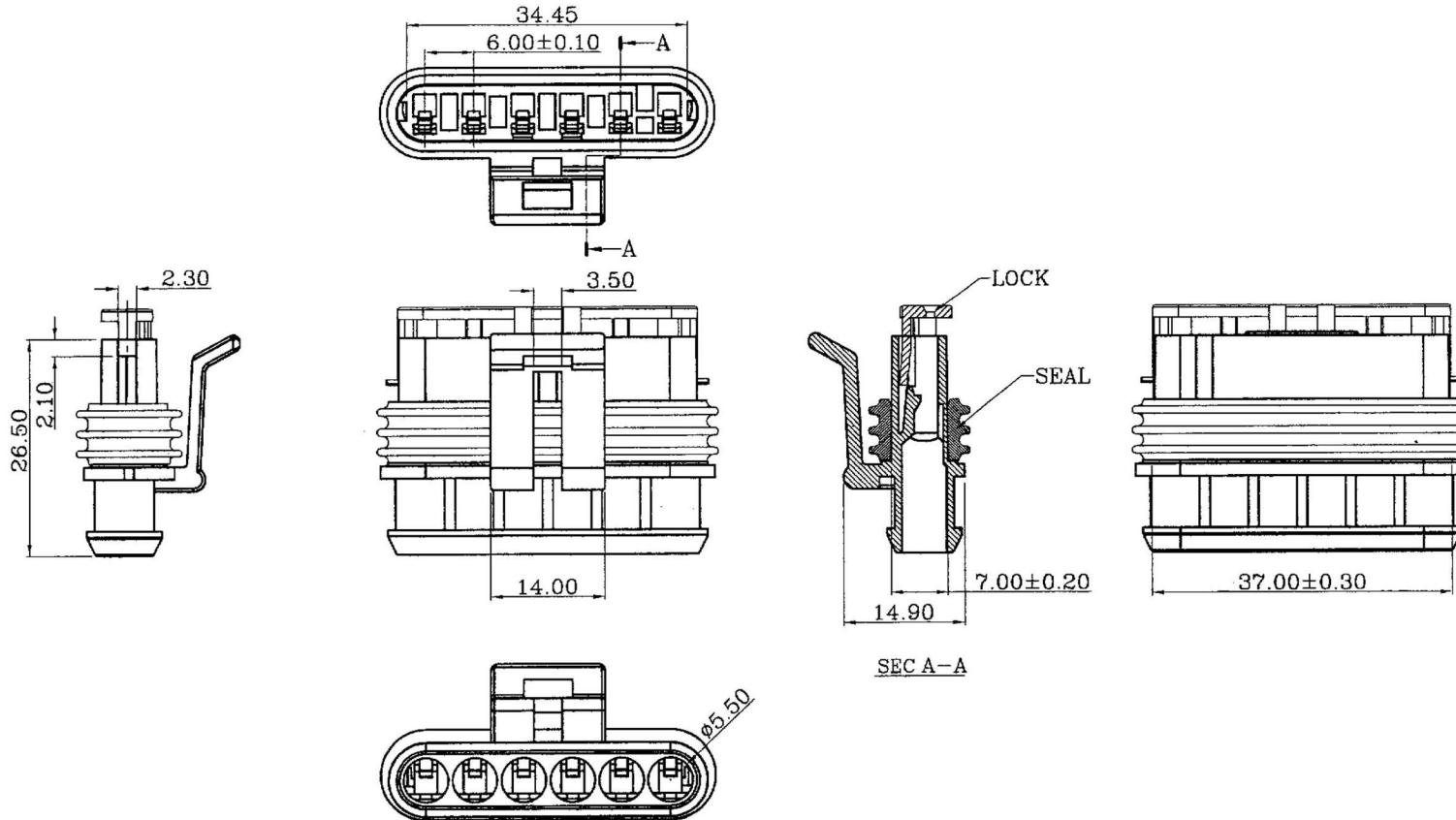

Date	22.10.2008	Rev.		Revision Detail		Rev.Dt.		Rev.by		Part No		
Designed by	Yeşim AKSOY		-							200001-6F		
Checked by	Fatih BOLACA											
										Drawing Nr.	Scale	Sheet No
										-	NONE	1/1